

# Rizzo

## JACKET



Sizes 2-20  
with cup sizes A-H

5/8 inch (in) (1.5 cm) seam allowances are included on all pattern pieces.

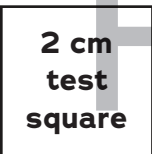
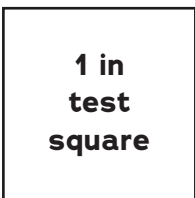

### SIZES 2-20 PATTERN SIZE KEY

2	—————
4	- - - - -
6	.....
8	- . - . -
10	.....
12	- . - . -
14	.....
16	- . - . -
18	- - - - -
20	.....

### SYMBOL KEY

grainline arrow



● match point/  
placement mark

⊕ bust apex

✕ button/buttonhole

© 2023 Charm Patterns by  
Gertie. Distribution and  
Commercial Use Prohibited.

PAGE

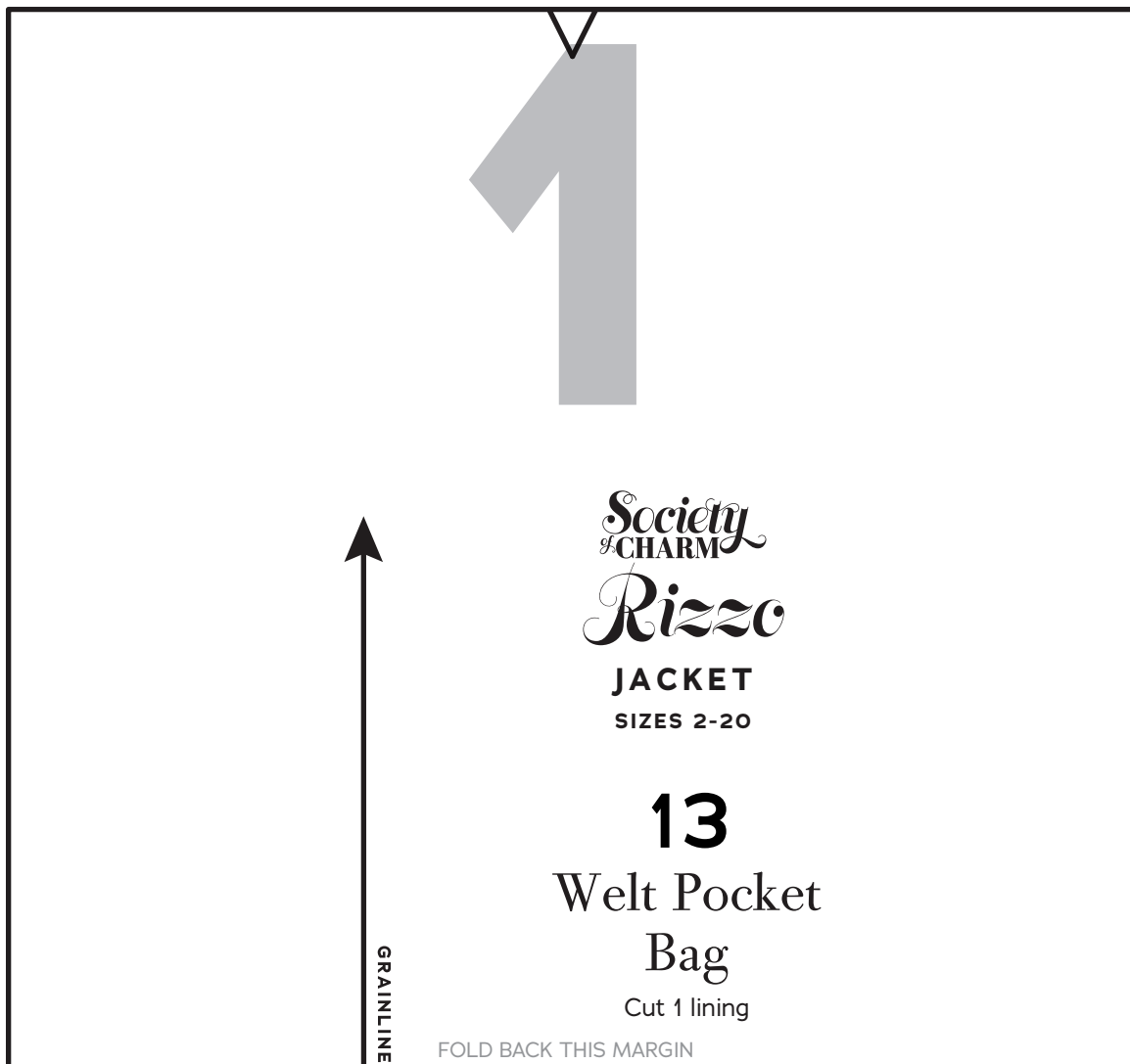

FOLD BACK THIS MARGIN

Society  
of CHARM  
Rizzo  
JACKET  
SIZES 2-20

**13**  
Welt Pocket  
Bag  
Cut 1 lining

GRAINLINE

FOLD BACK THIS MARGIN

A1

# PAGE 2

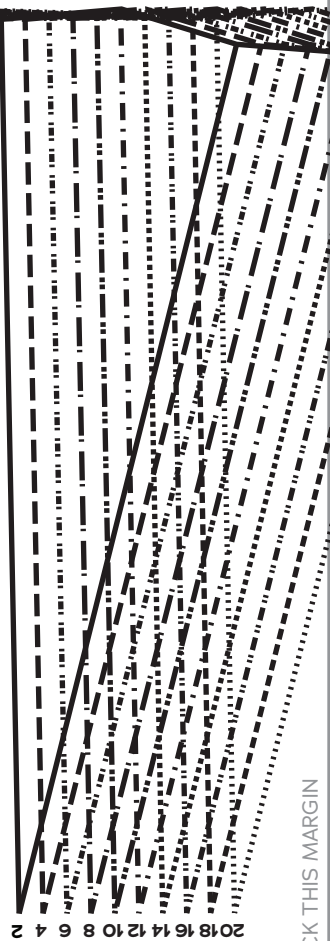

FOLD BACK THIS MARGIN



2018 16 14 12 10 8 6 4 2



A1

FOLD BACK THIS MARGIN

A2

# PAGE 3

FOLD BACK THIS MARGIN

2

4

6

8

10

A2

FOLD BACK THIS MARGIN

A3

PAGE  
4

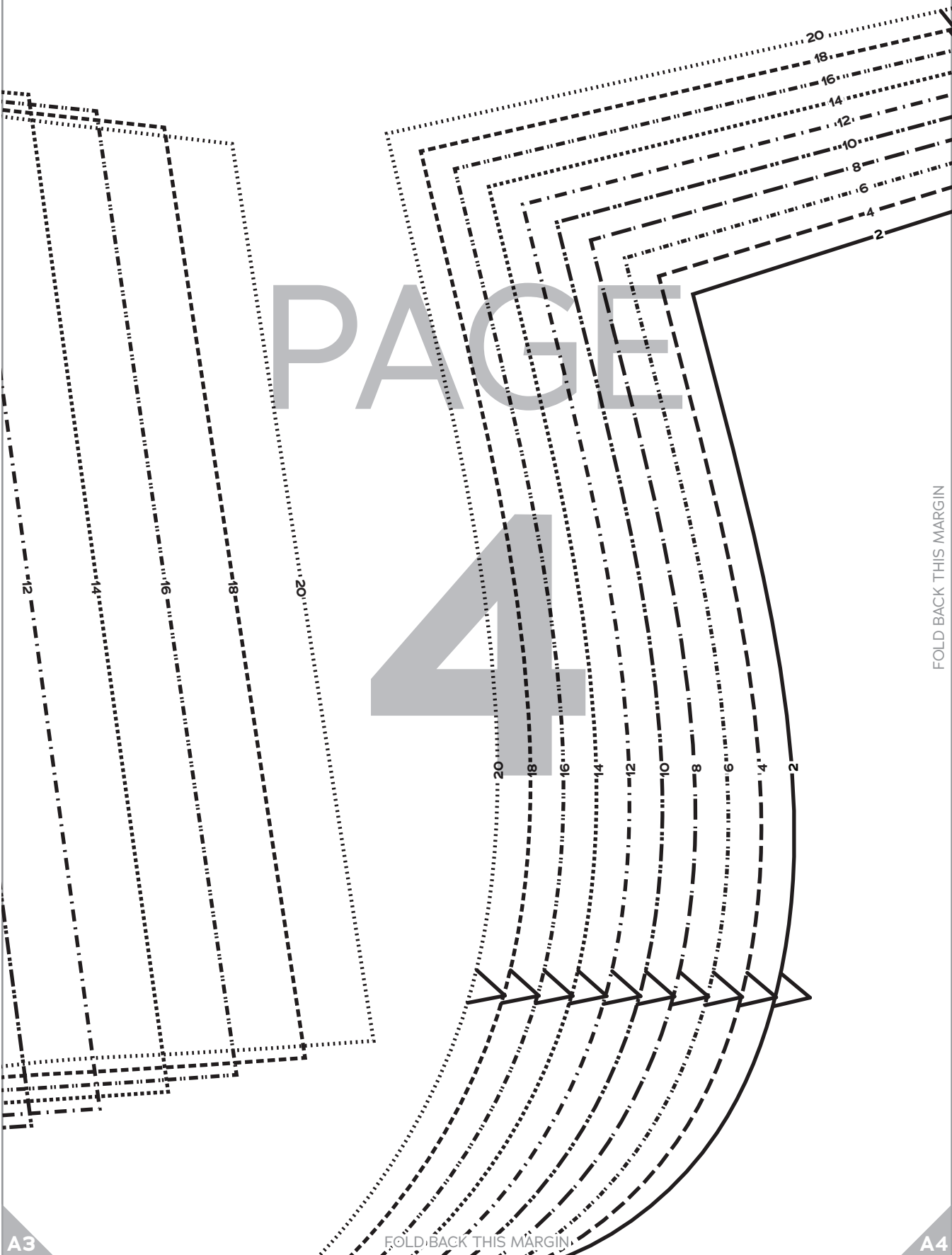

FOLD BACK THIS MARGIN

FOLD BACK THIS MARGIN

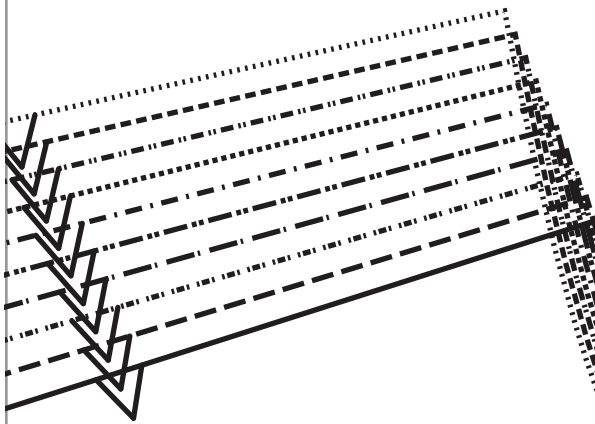

PAGE

5

Society  
of CHARM

Rizzo

JACKET

SIZES 2-20

1

Jacket Front,  
B/C Cup

Cut 2 fabric



GRAINLINE

FOLD BACK THIS MARGIN

A4

FOLD BACK THIS MARGIN

A5

PAGE

6

WELT POCKET

FOLD BACK THIS MARGIN

2

4



A5

FOLD BACK THIS MARGIN

A6

PAGE

7

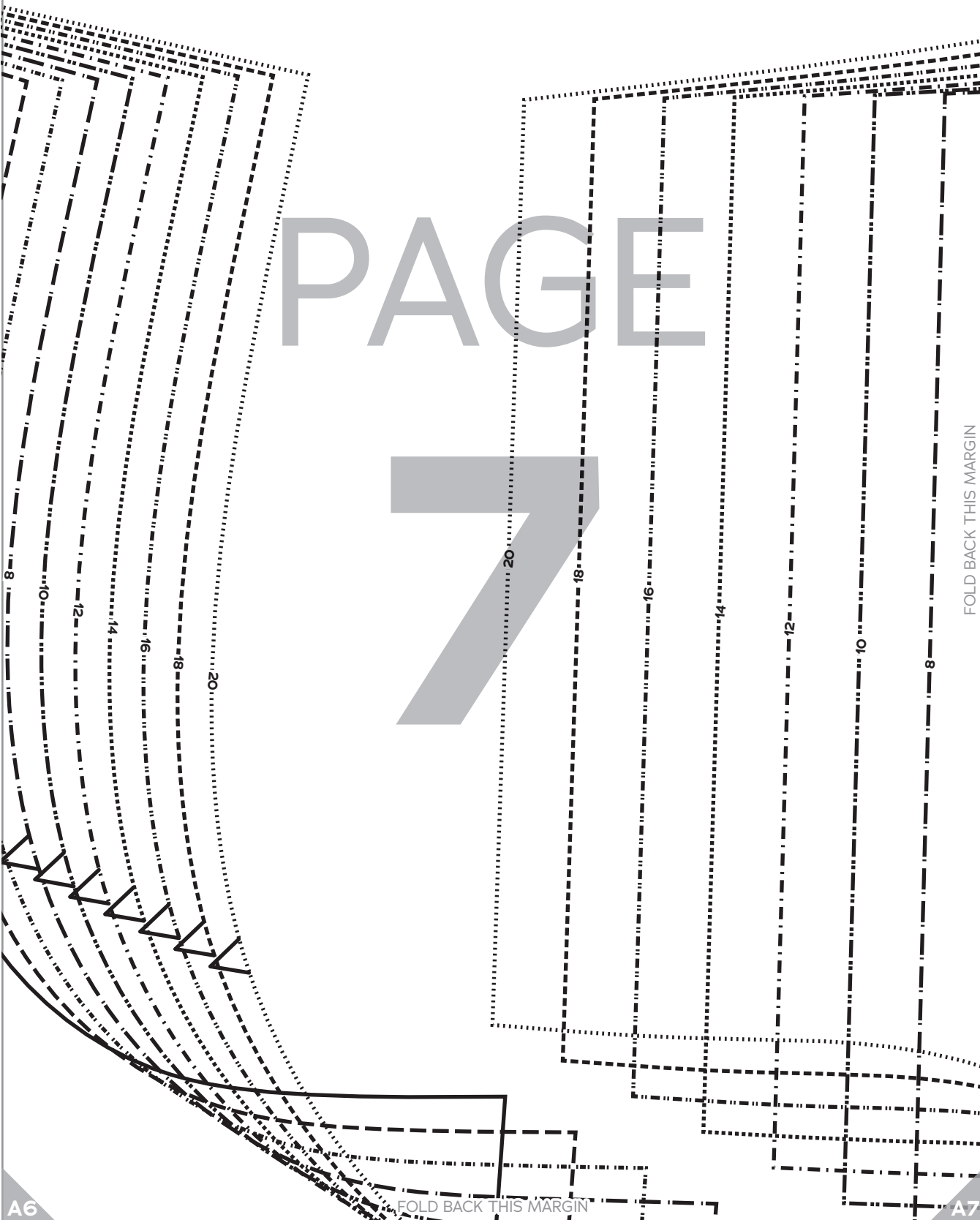

A6

FOLD BACK THIS MARGIN

A7

# PAGE 8

Lining Front,  
F/G Cup  
Cut 2 lining

10

SIZES 2-20

JACKET

*Rizzo*  
*Society*  
of CHARM

FOLD BACK THIS MARGIN

FOLD BACK THIS MARGIN

A7

A8



# PAGE 9

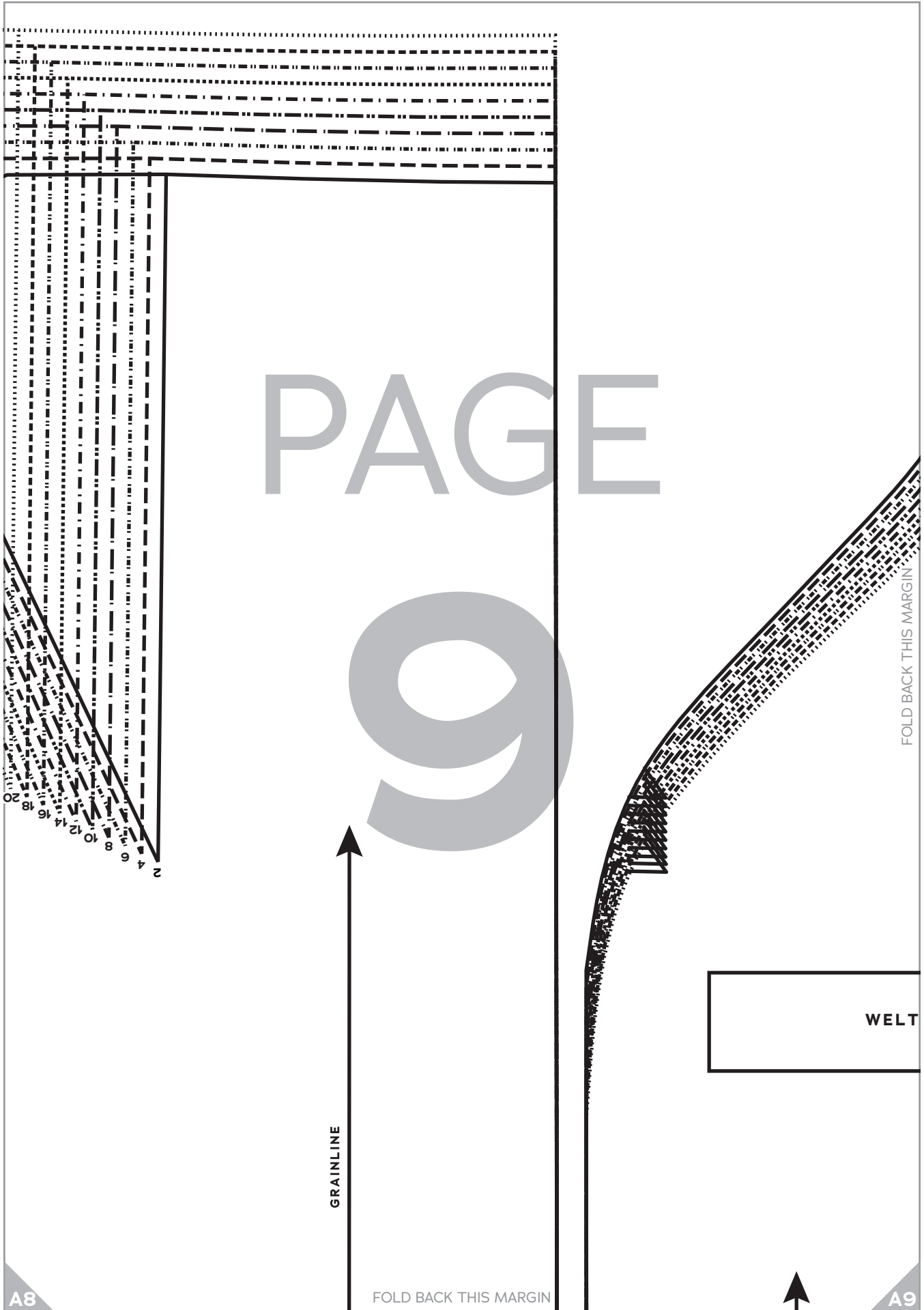

PAGE

10

POCKET

A9

FOLD BACK THIS MARGIN

FOLD BACK THIS MARGIN

A10

PAGE

11

FOLD BACK THIS MARGIN

A10

FOLD BACK THIS MARGIN

A11

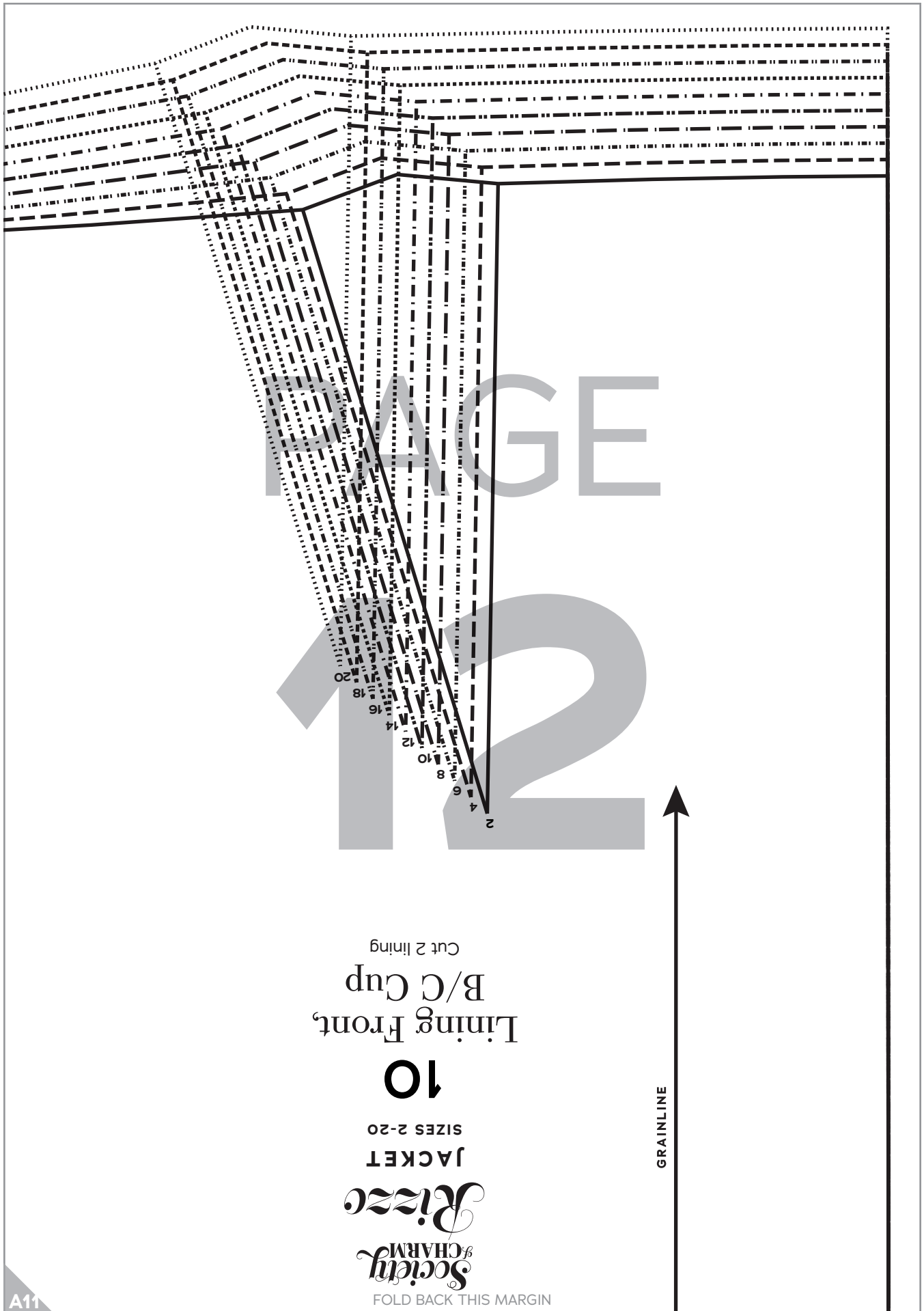

Lining Front,  
B/C Cup  
Cut 2 lining

10

SIZES 2-20

JACKET

*Rizzo*  
Society  
of CHARM

FOLD BACK THIS MARGIN

GRAINLINE

A11



PAGE

13

FOLD BACK THIS MARGIN

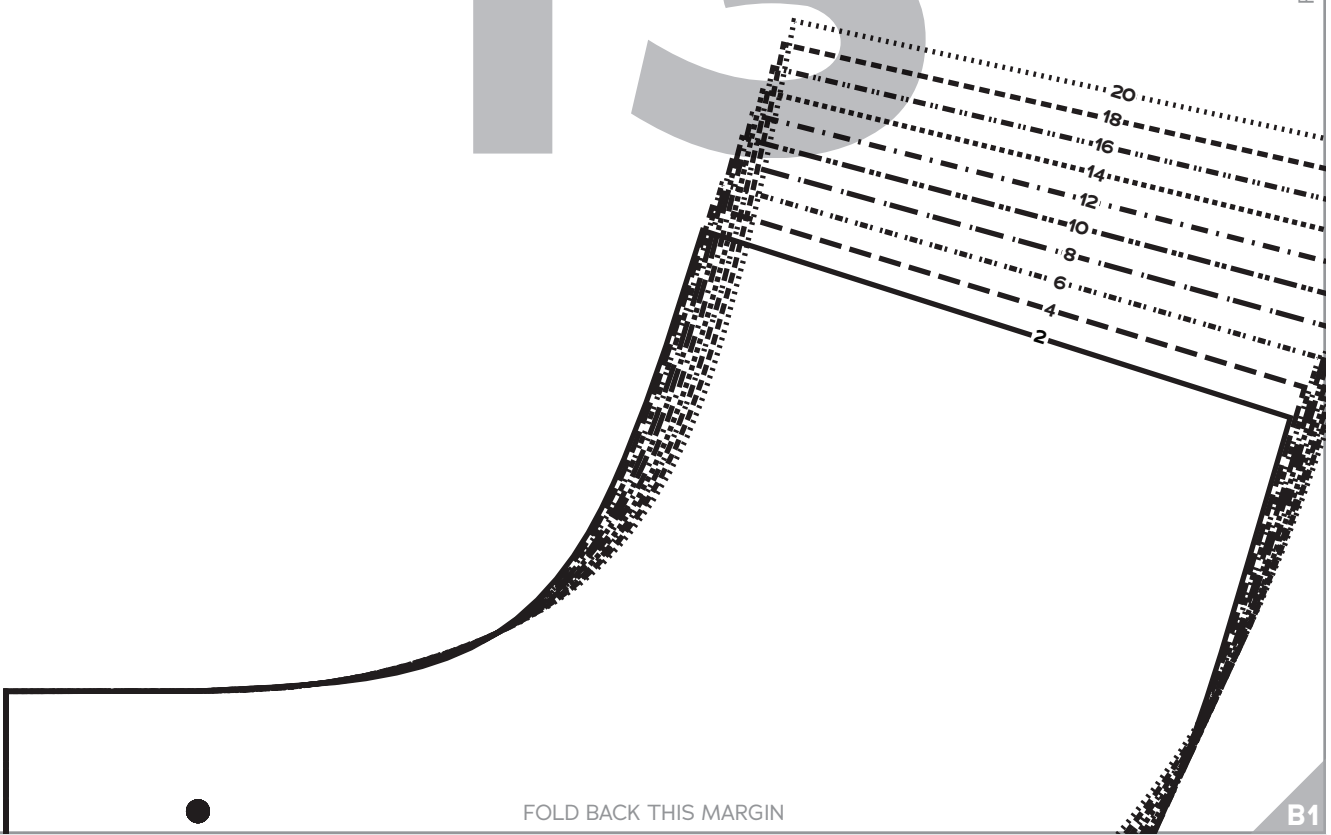

FOLD BACK THIS MARGIN

A1

A2

Jacket Front,  
A Cup  
Cut 2 fabric



SIZES 2-20

JACKET

*Rizzo*  
Society of CHARM

PAGE

GRAINLINE



14

FOLD BACK THIS MARGIN

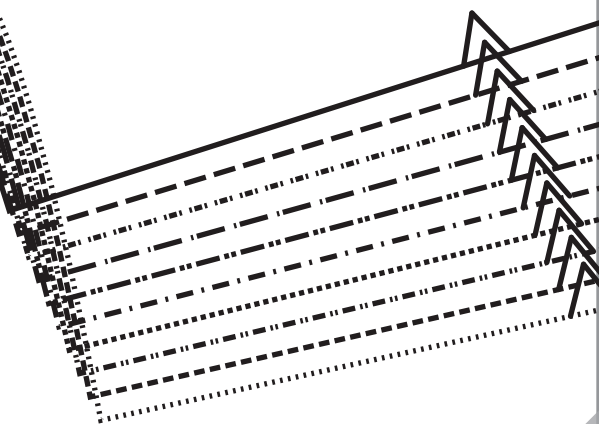

B1

FOLD BACK THIS MARGIN

B2

A2

A3

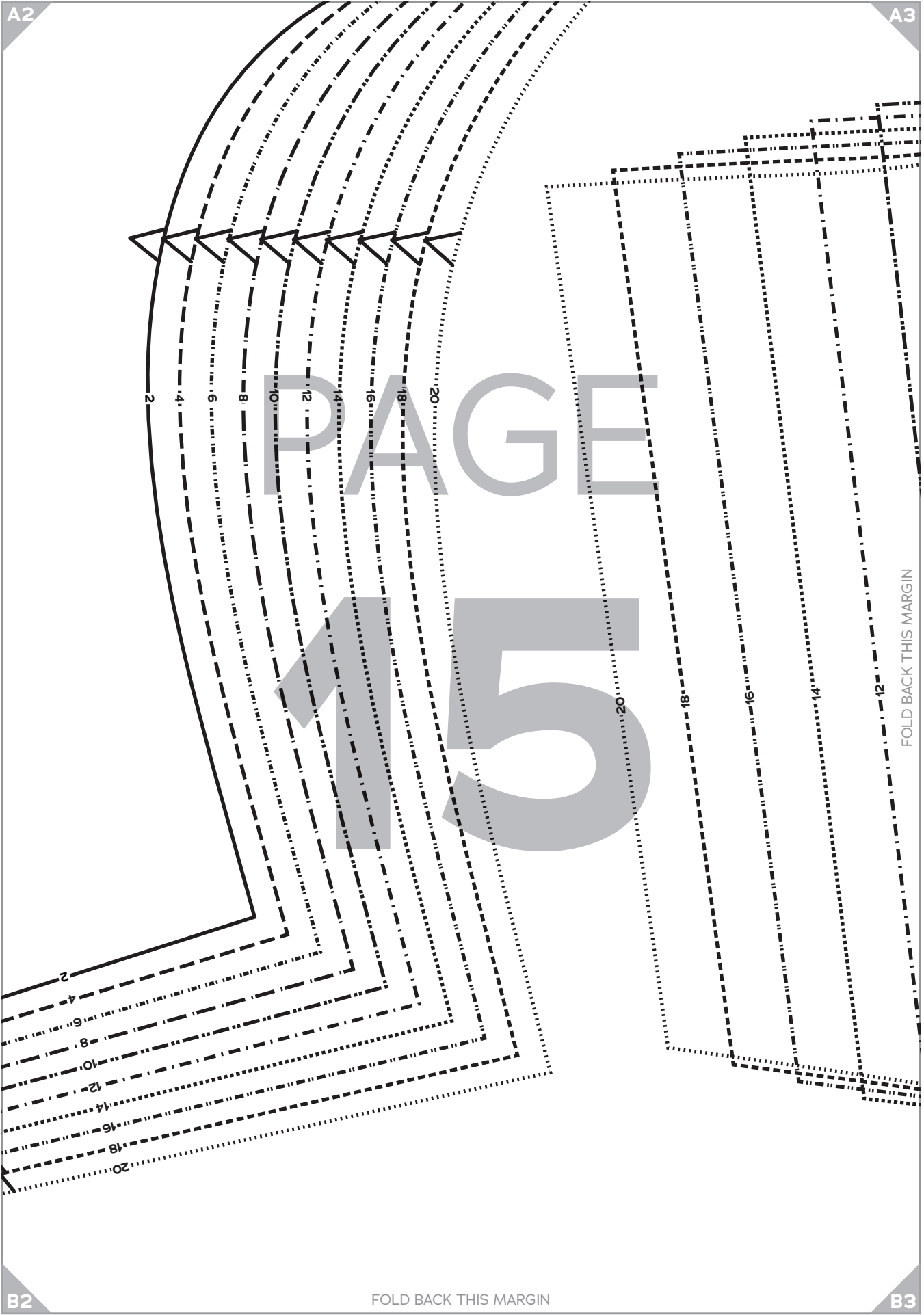

PAGE  
15

FOLD BACK THIS MARGIN

FOLD BACK THIS MARGIN

B2

B3

A3

A4

# PAGE 16

FOLD BACK THIS MARGIN

FOLD BACK THIS MARGIN

B3

B4



A4

A5



2018 16 14 12 10 8 6 4 2

# PAGE

# 17

2018 16 14 12 10 8 6 4 2

FOLD BACK THIS MARGIN

B4

FOLD BACK THIS MARGIN

B5

A5

A6

Society  
of CHARM  
*Rizzo*

JACKET  
SIZES 2-20

10

Lining Front,  
D/DD Cup

Cut 2 lining

GRAINLINE

PAGE

10

FOLD BACK THIS MARGIN

2  
4  
6  
8  
10  
12  
14  
16  
18  
20

B5

FOLD BACK THIS MARGIN

B6

A6

A7

# PAGE 19

FOLD BACK THIS MARGIN

FOLD BACK THIS MARGIN

B6

B7

A7

A8

B7

B8

PAGE  
20

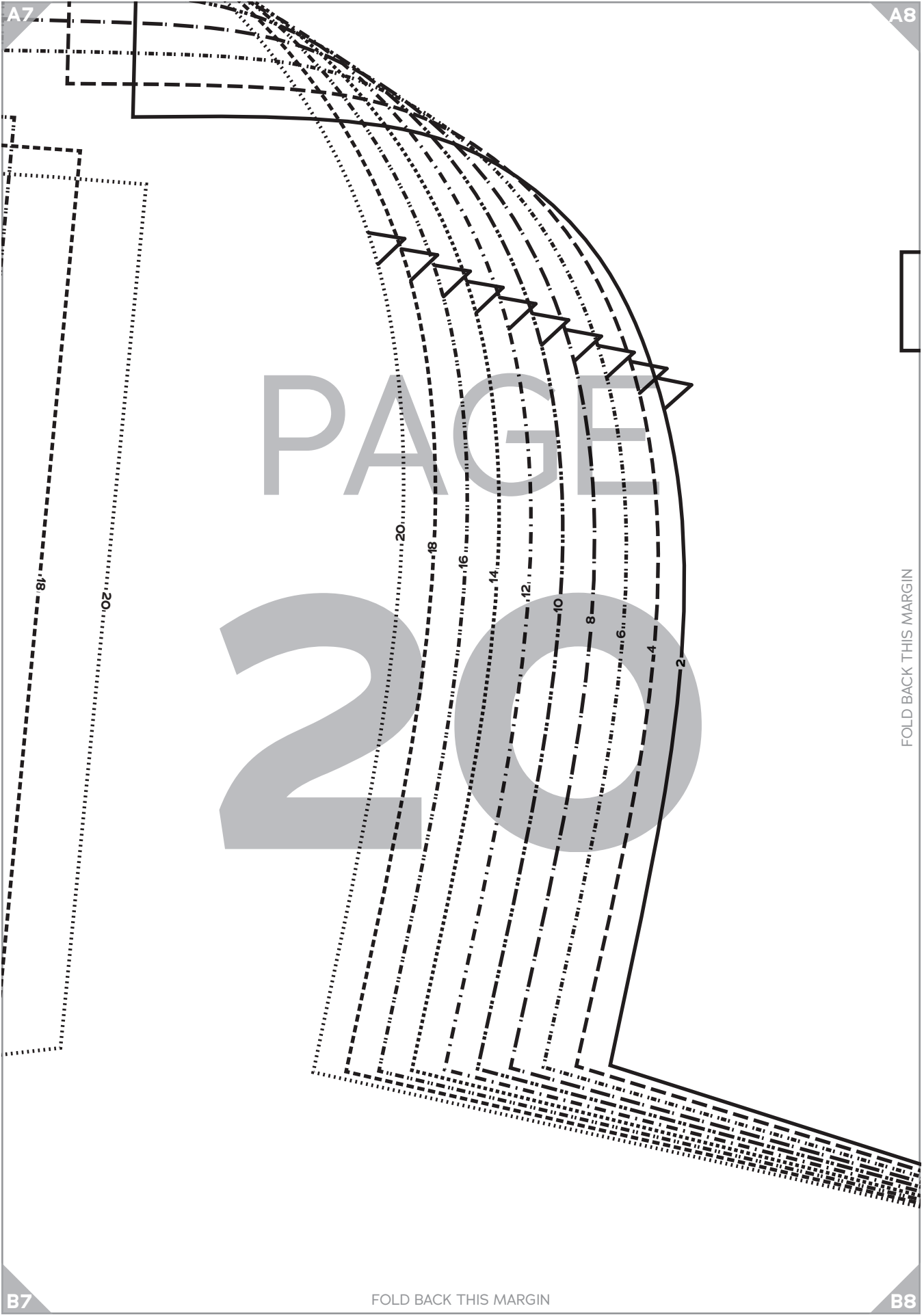

18

20

20

18

16

14

12

10

8

6

4

2

FOLD BACK THIS MARGIN

FOLD BACK THIS MARGIN

A8

A9

WELT POCKET

GRAINLINE

PAGE 21

FOLD BACK THIS MARGIN

FOLD BACK THIS MARGIN

B8

B9

A9

A10

Society  
of CHARM  
Rizzo

JACKET

SIZES 2-20

10

Lining Front,

A Cup

Cut 2 lining

PAGE

22

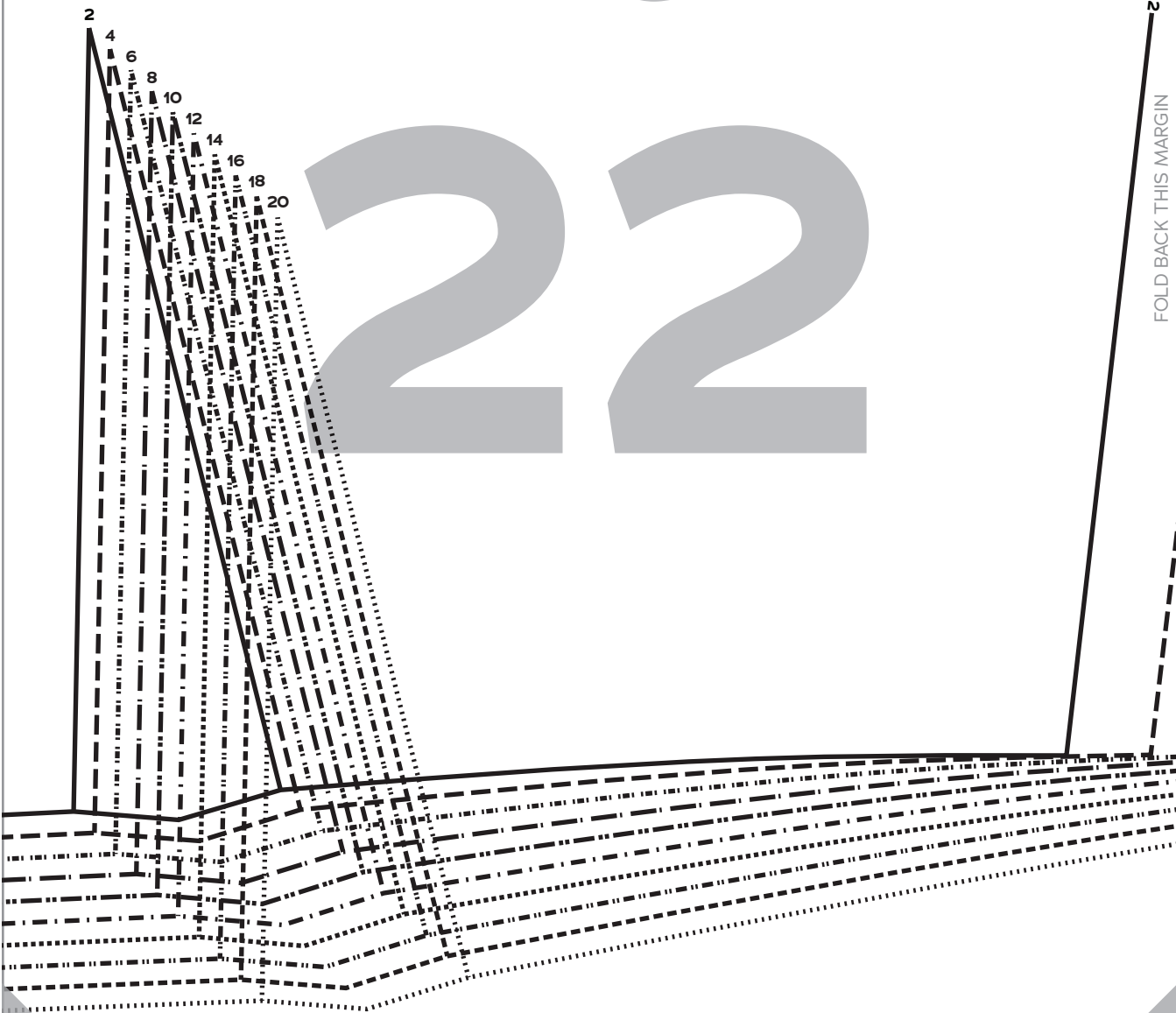

FOLD BACK THIS MARGIN

FOLD BACK THIS MARGIN

B9

B10

A10

A11

PAGE

23

4

6

8

10

12

14

16

18

20

20

18

16

14

12

FOLD BACK THIS MARGIN

B10

FOLD BACK THIS MARGIN

B11

A11



WELT POCKET

PAGE

24

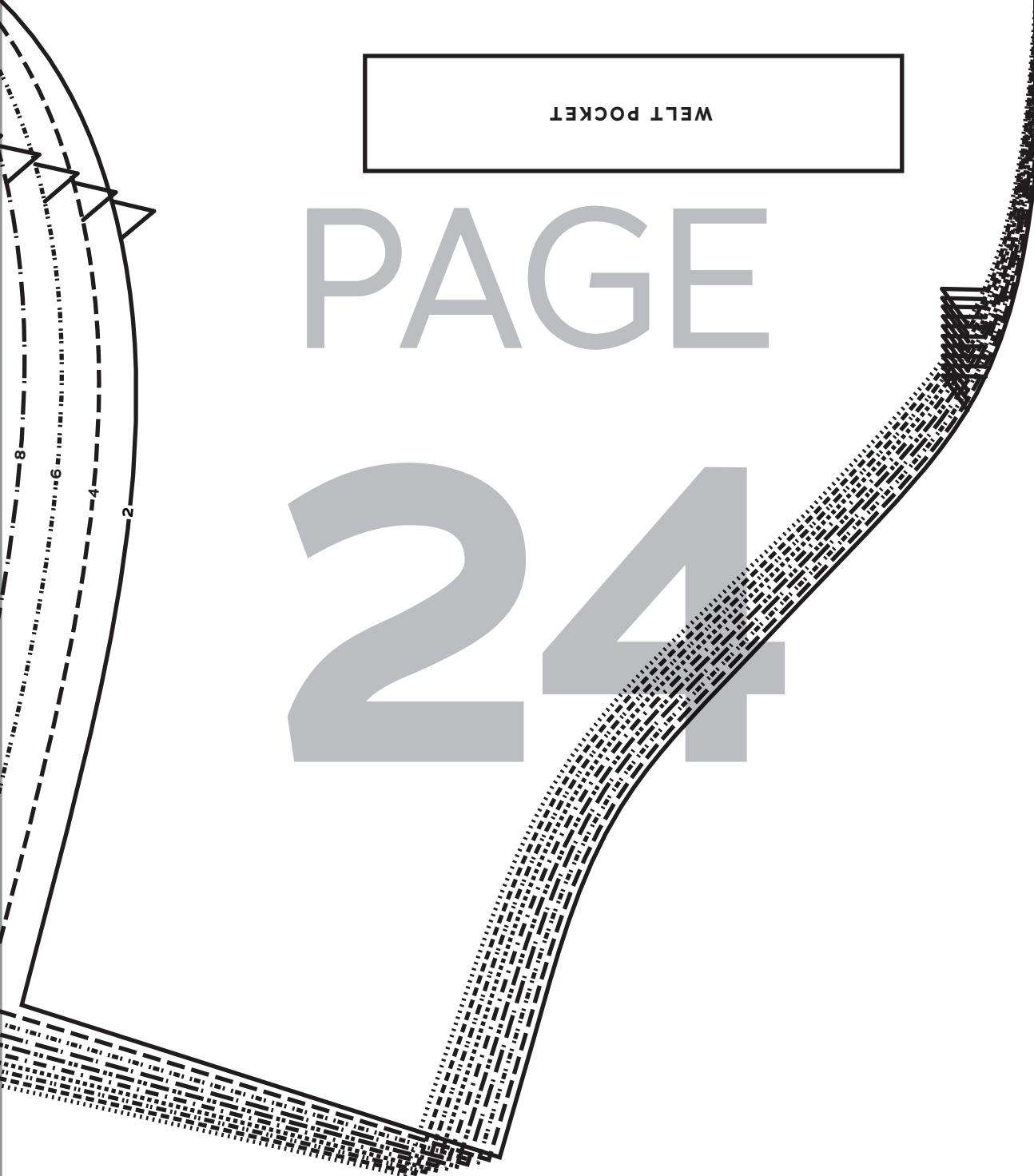

8  
6  
4  
2

B11

FOLD BACK THIS MARGIN



Society  
of CHARM  
Rizzo

JACKET  
SIZES 2-20

9

Front Facing  
Cut 2 fabric, 2 interfacing

PAGE

25



GRAINLINE

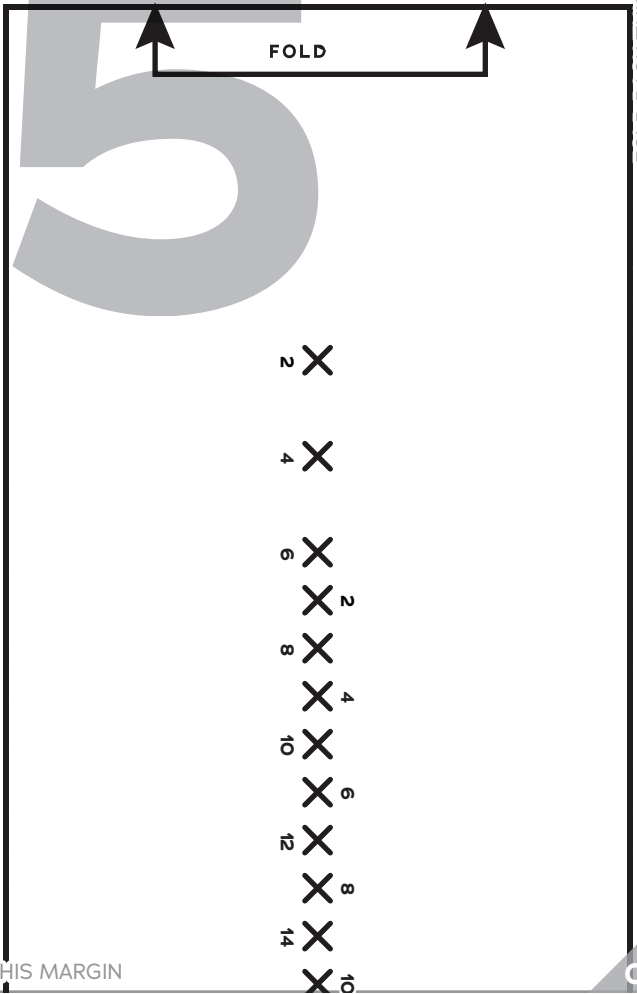

FOLD BACK THIS MARGIN

FOLD BACK THIS MARGIN

B1

B2

# PAGE 26

20 18 16 14 12 10 8 6 4 2  
⊕ ⊕ ⊕ ⊕ ⊕ ⊕ ⊕ ⊕ ⊕ ⊕

FOLD BACK THIS MARGIN

FOLD BACK THIS MARGIN



C1

C2

B2

B3

PAGE

27

FOLD BACK THIS MARGIN

2

4

6

8

C2

FOLD BACK THIS MARGIN

C3

B3

B4

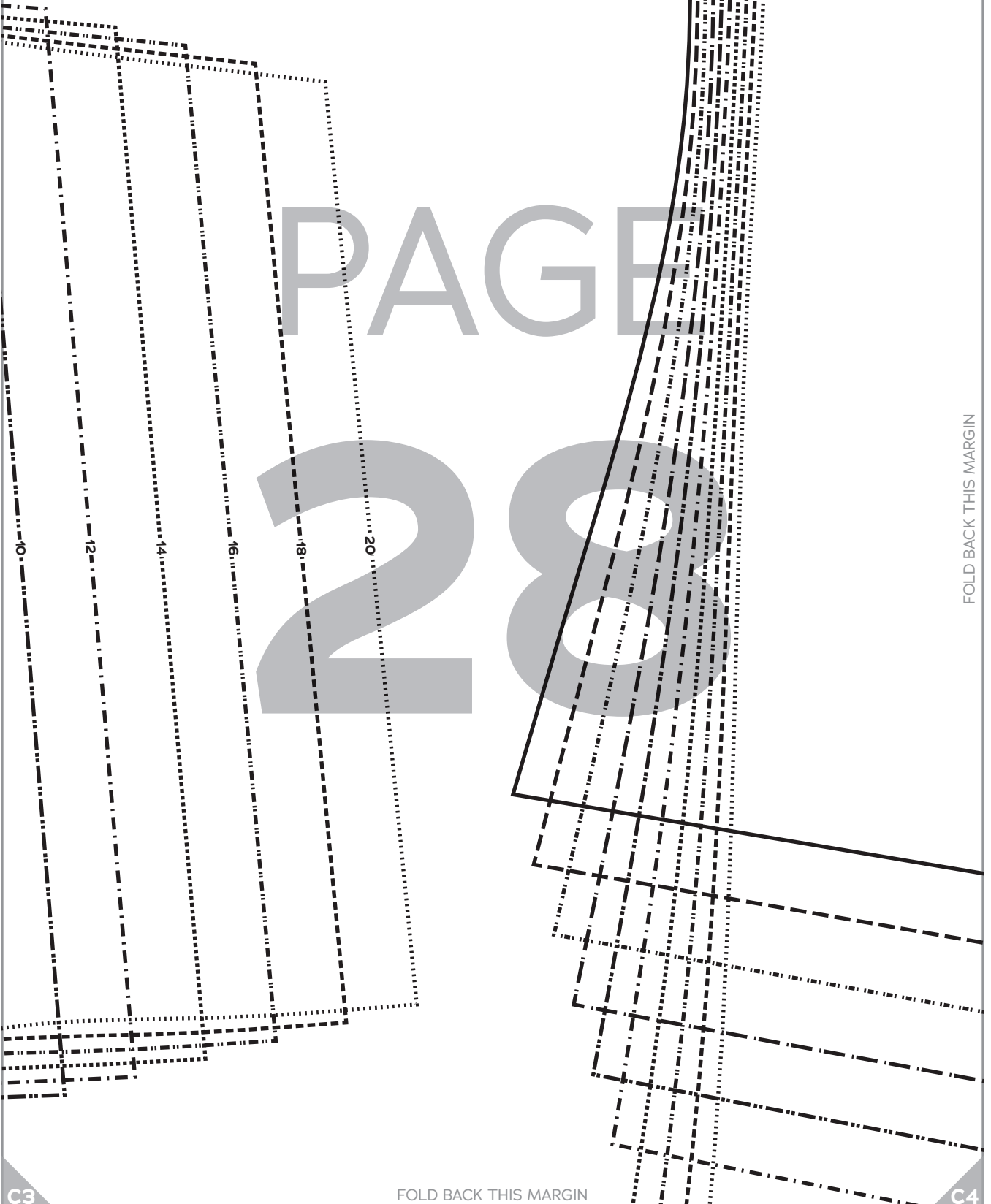

PAGE

28

FOLD BACK THIS MARGIN

C3

FOLD BACK THIS MARGIN

C4

B4

B5

FOLD



Society  
 of CHARM  
*Rizzo*  
 JACKET  
 SIZES 2-20  
**2**  
 Jacket  
 Back  
 Cut 1 fabric on fold  
**29**

FOLD BACK THIS MARGIN

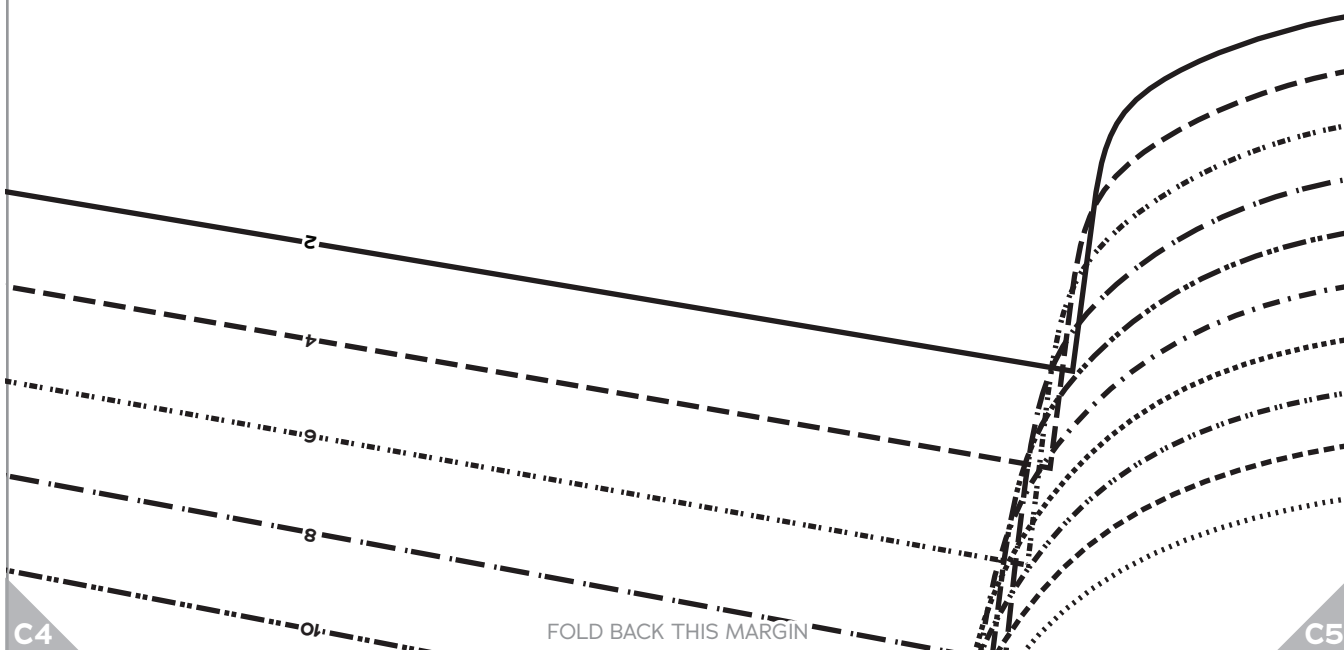

C4

C5

B5

B6

PAGE

30

FOLD BACK THIS MARGIN

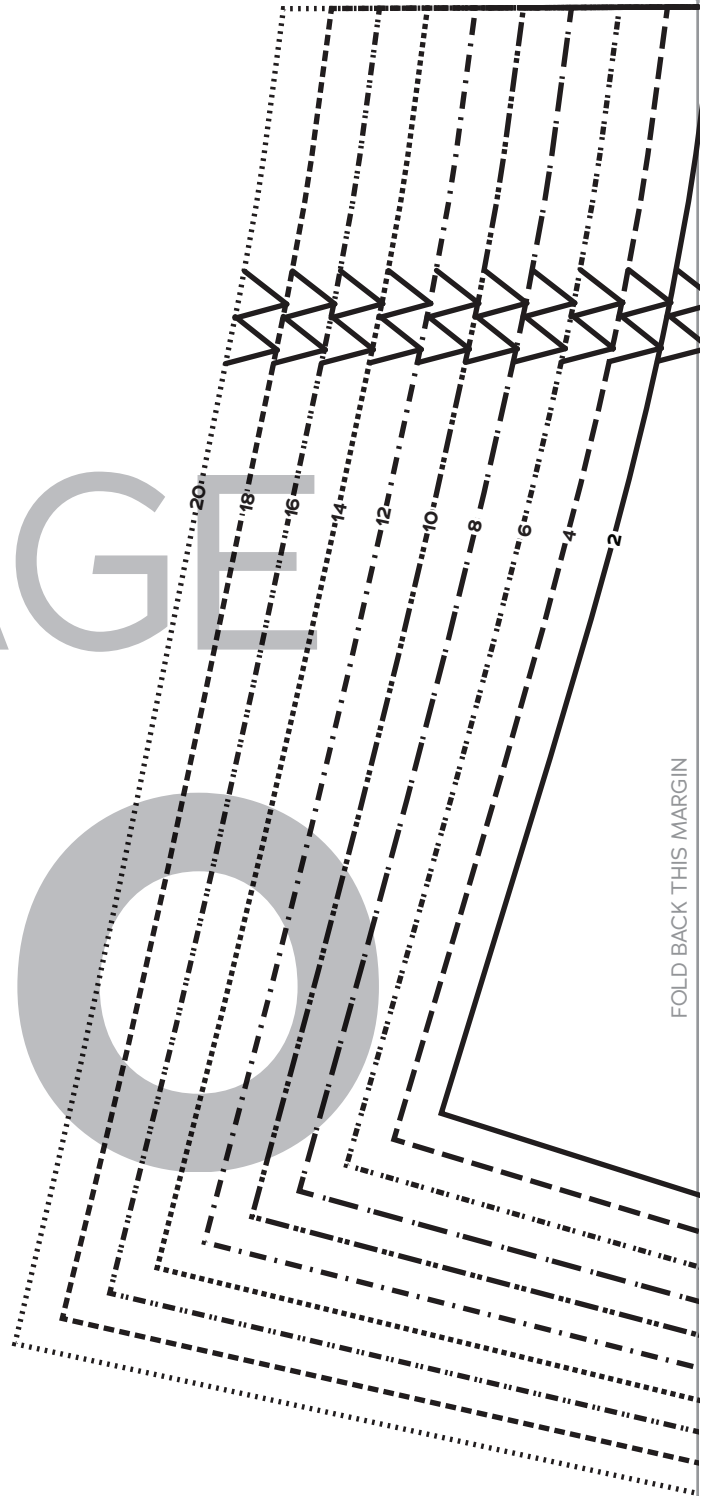
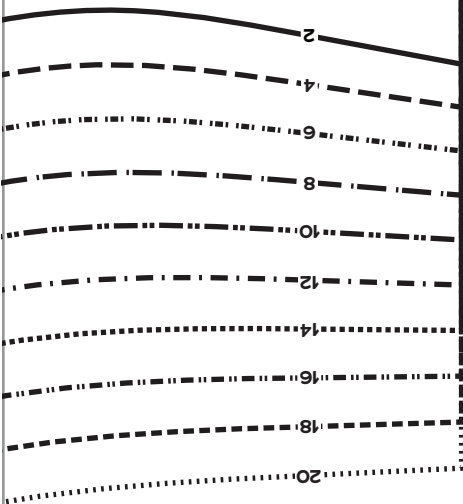

C5

FOLD BACK THIS MARGIN

C6

Cut 1 fabric on fold

Yoke

3

JACKET  
SIZES 2-20

*Rizzo*  
Society of CHARM

PAGE

31

FOLD

FOLD BACK THIS MARGIN

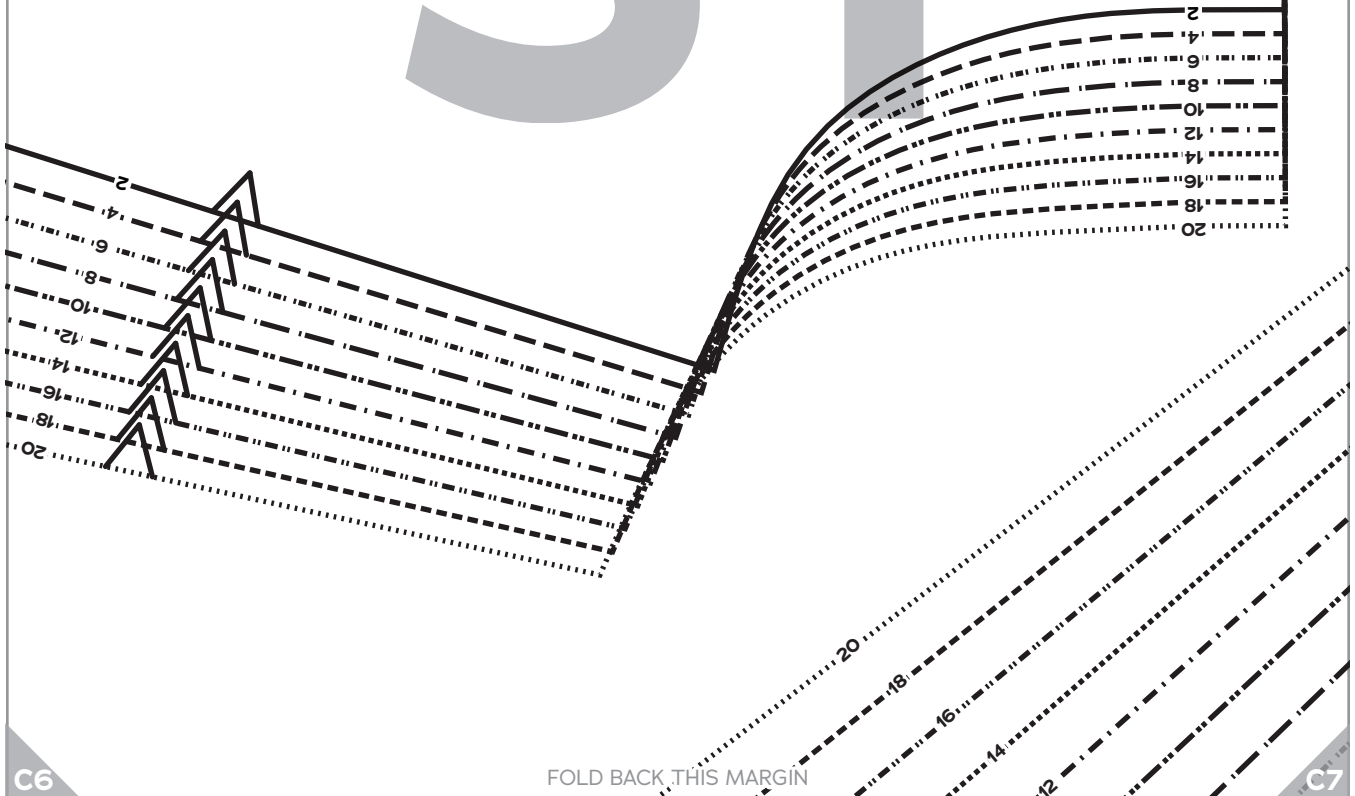

B7

B8

PAGE

32

FOLD BACK THIS MARGIN

C7

FOLD BACK THIS MARGIN

C8



B8

B9

PAGE

33

FOLD BACK THIS MARGIN

C8

FOLD BACK THIS MARGIN

C9

B9

B10

PAGE

34

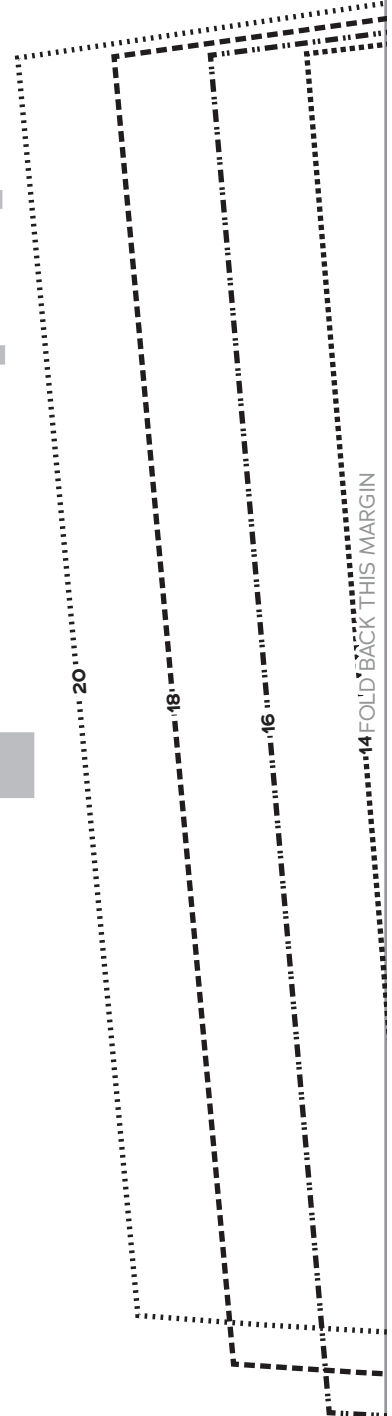
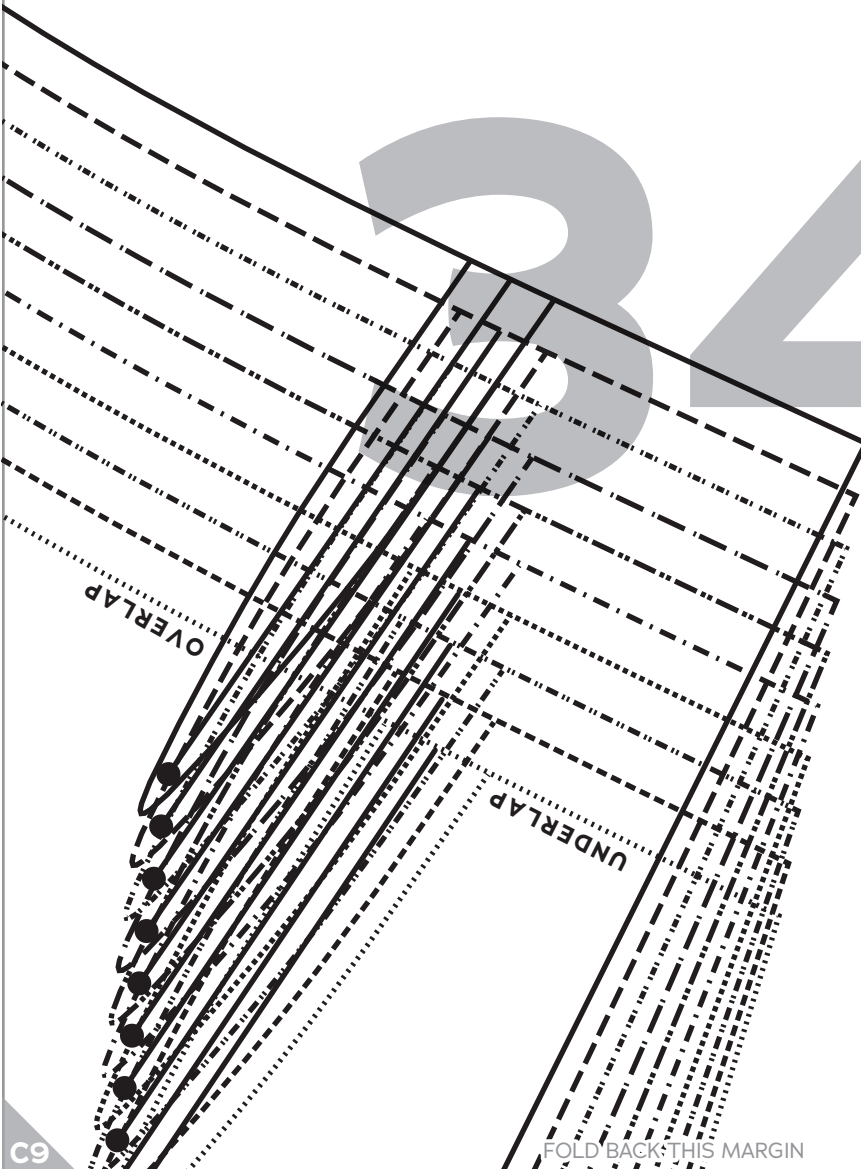

C9

C10

B10

B11

PAGE

35

FOLD BACK THIS MARGIN

12

10

8

6

4

2

C10

FOLD BACK THIS MARGIN

C11

B11

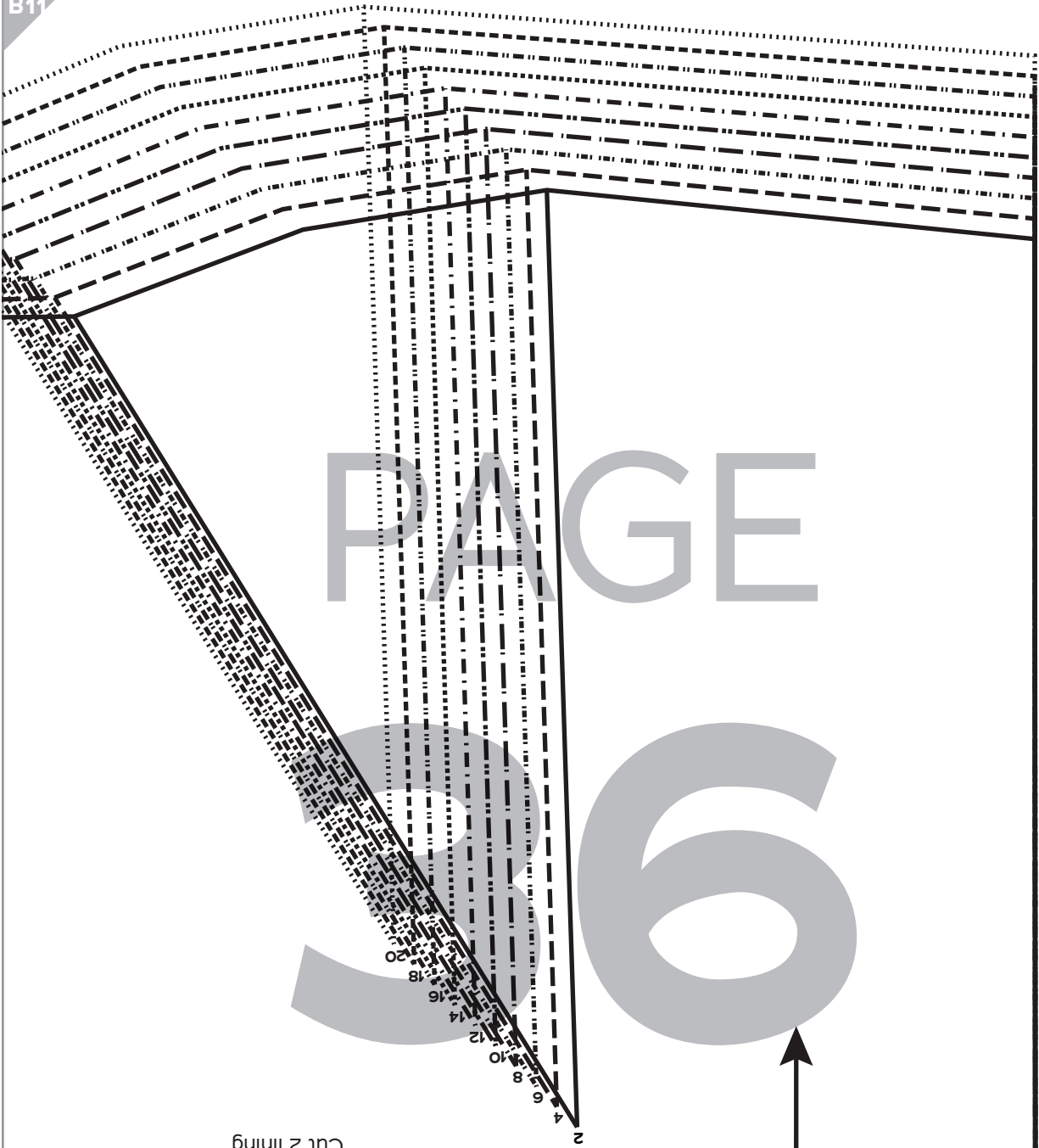

Lining Front, H Cup  
Cut 2 lining

10

JACKET  
SIZES 2-20

*Society of Charm*  
*Rizzo*

GRAINLINE

FOLD BACK THIS MARGIN

C11



C1

C2

Jacket Front,  
D/DD Cup  
Cut 2 fabric



JACKET  
SIZES 2-20

*Rizzo*  
Society  
of CHARM

PAGE

38

GRAINLINE

FOLD BACK THIS MARGIN

D1

FOLD BACK THIS MARGIN

D2

C2

C3

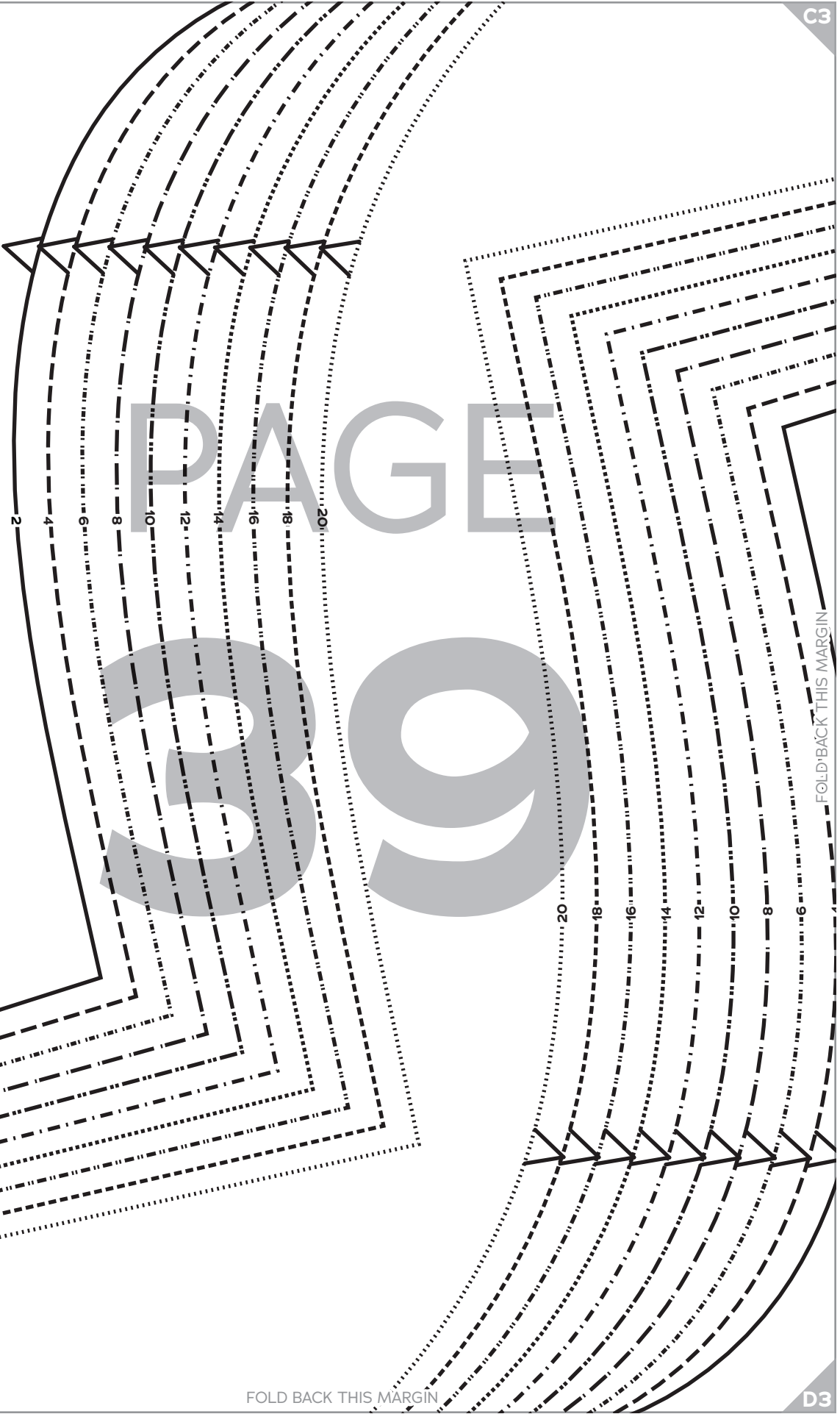

PAGE

39

2 4 6 8 10 12 14 16 18 20

20 18 16 14 12 10 8 6

FOLD BACK THIS MARGIN

FOLD BACK THIS MARGIN

D2

D3

C3

C4

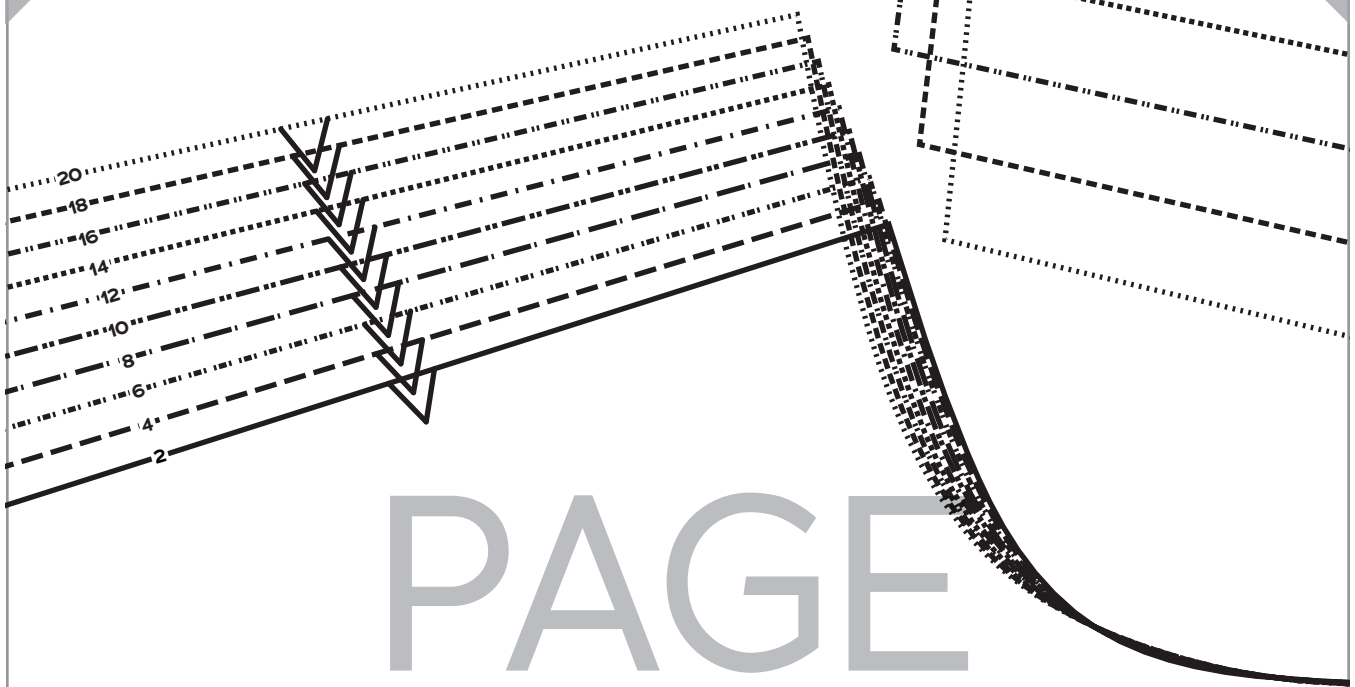

PAGE

40

FOLD BACK THIS MARGIN



GRAINLINE

*Society*  
*of CHARM*  
*Rizzo*

**JACKET**  
 SIZES 2-20

**1**

Jacket Front,  
 F/G Cup

Cut 2 fabric

D3

FOLD BACK THIS MARGIN

D4



C4

C5

PAGE

**4** x **5**  
**Waist Tab**  
 Cut 4 fabric, 2 interfacing

*Society of CHARM*  
**Rizzo**  
**JACKET**  
**SIZES 2-20**

GRAINLINE

D4

FOLD BACK THIS MARGIN

D5

C5

C6

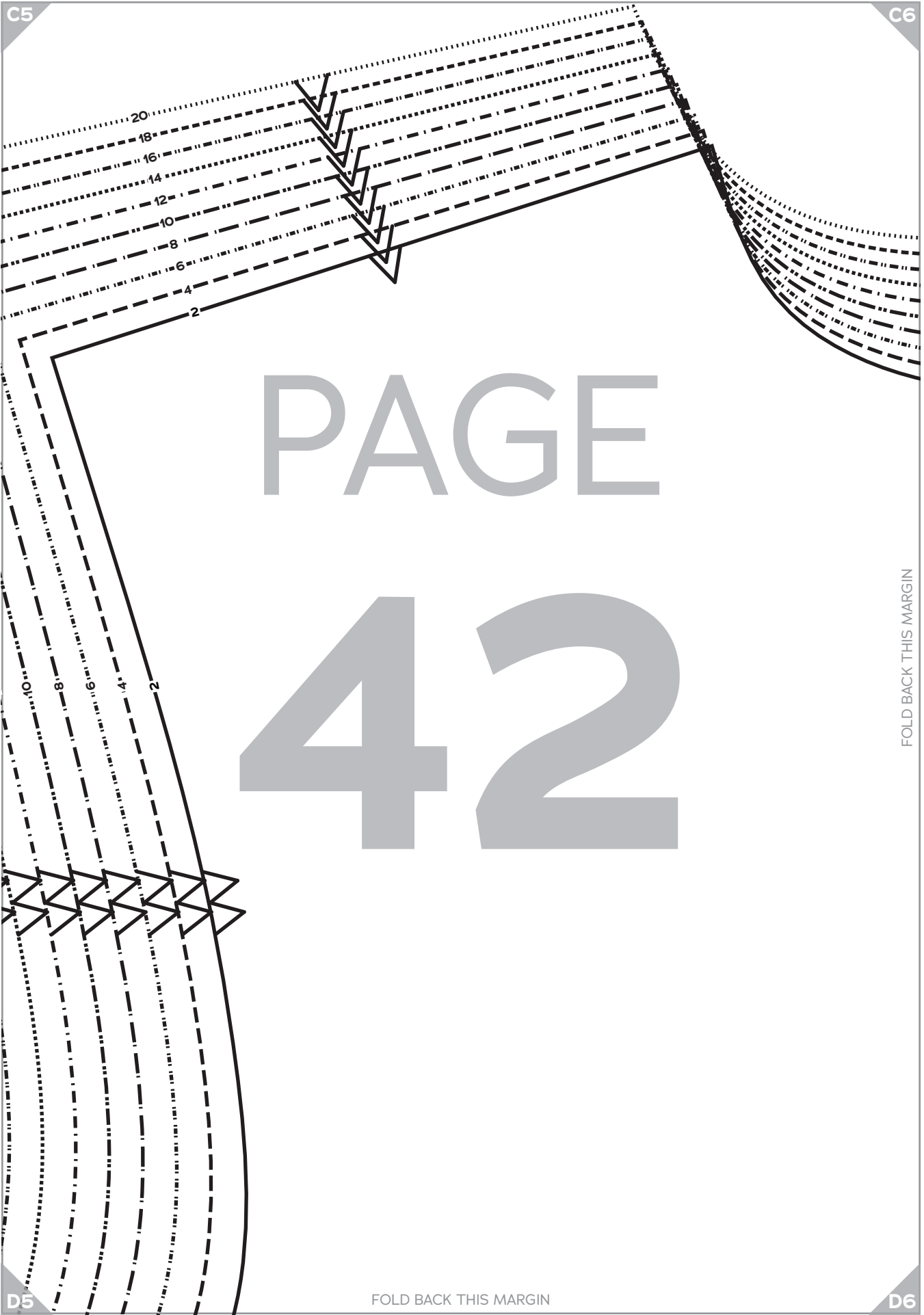

PAGE

42

FOLD BACK THIS MARGIN

FOLD BACK THIS MARGIN

D5

D6

C6

C7

20  
18  
16  
14  
12  
10  
8  
6  
4  
2

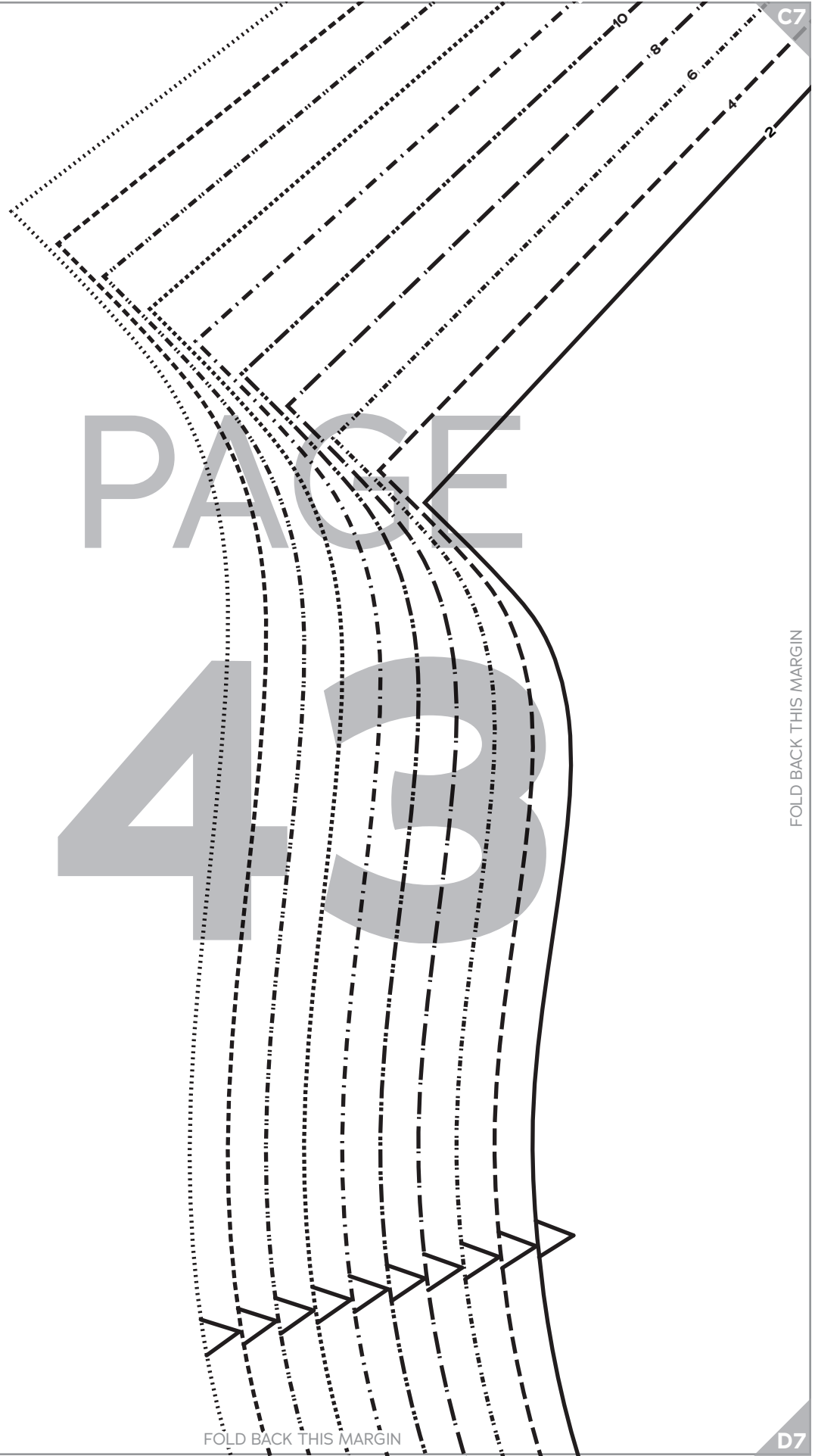

PAGE

43

FOLD BACK THIS MARGIN

FOLD BACK THIS MARGIN

D6

D7

C7

C8

PAGE

44

Sleeve  
Cut 2 fabric, 2 lining

6

*Society of Charm*  
**Rizzo**  
JACKET  
SIZES 2-20

GRAIN  
FOLD BACK THIS MARGIN



D7

FOLD BACK THIS MARGIN

D8

C8

C9



PAGE

45

FOLD BACK THIS MARGIN

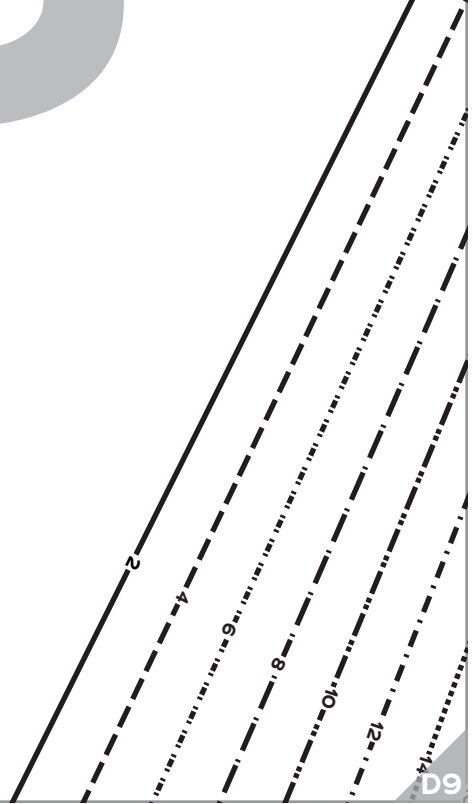

D8

FOLD BACK THIS MARGIN

D9

C9

C10

PAGE

446

20  
18  
16  
14  
12  
10  
8  
6  
4  
2

FOLD BACK THIS MARGIN

FOLD BACK THIS MARGIN

D9

D10

C10

C11

PAGE

47

20

18

16

14

12

10

8

FOLD BACK THIS MARGIN

D10

FOLD BACK THIS MARGIN.

D11

C11



WELT POCKET

PAGE

48



4

2

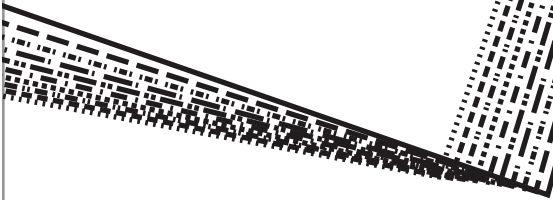

D11

20

FOLD BACK THIS MARGIN



**7** Sleeve Cuff  
Cut 4 fabric,  
2 interfacing

*Society of CHARM*  
*Rizzo*  
**JACKET**  
SIZES 2-20

GRAINLINE



20 18 16 14 12 10 8 6 4 2

OVERLAP



20 18 16 14 12 10 8 6 4 2

49

PAGE

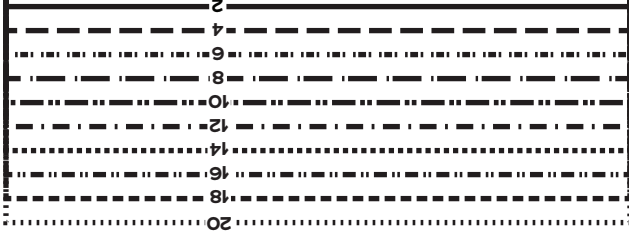

2 4 6 8 10 12 14 16 18 20

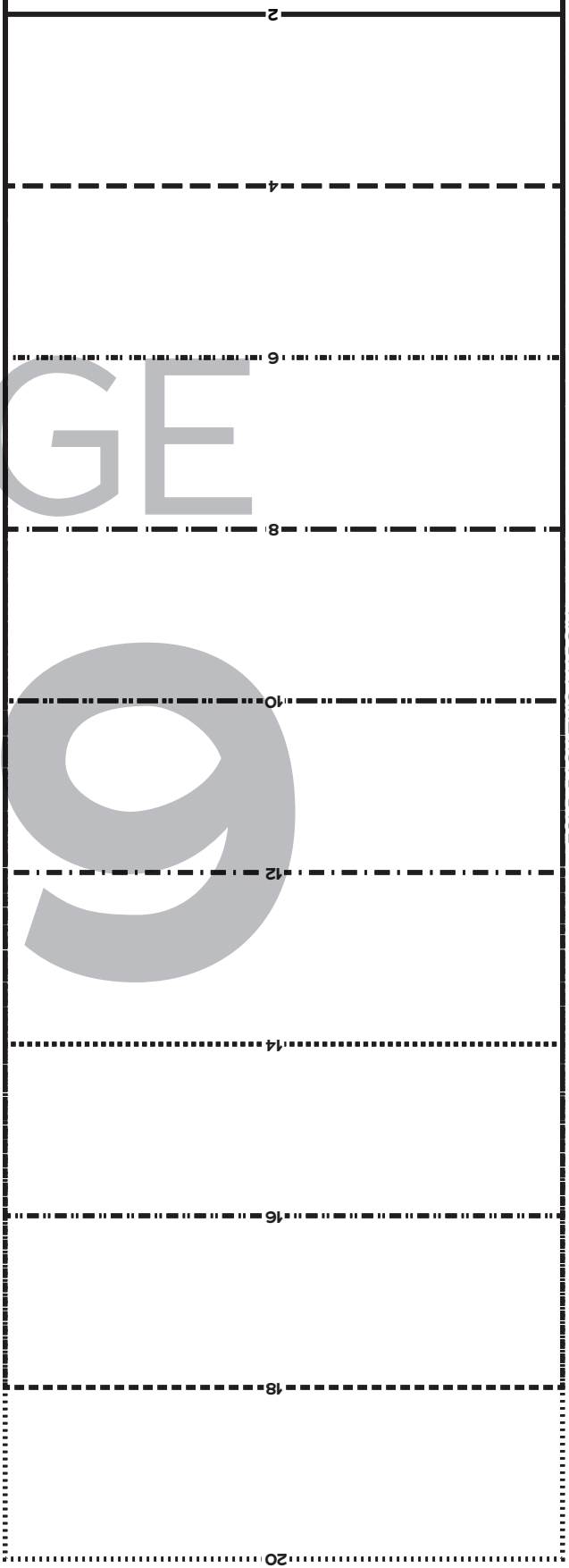

2 4 6 8 10 12 14 16 18 20

FOLD BACK THIS MARGIN

PAGE

GRAINLINE

Society  
& CHARM  
*Rizzo*  
JACKET  
SIZES 2-20

12  
Welt Pocket  
Cut 1 lining, 1 interfacing

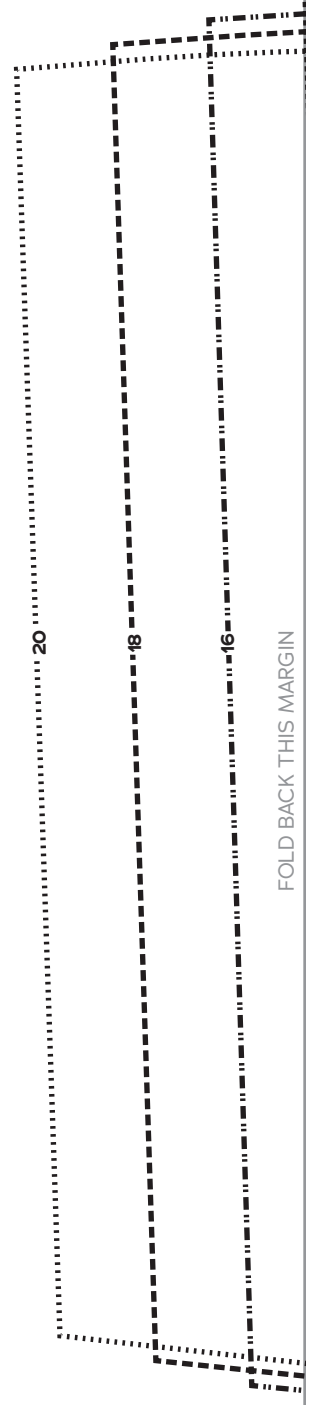
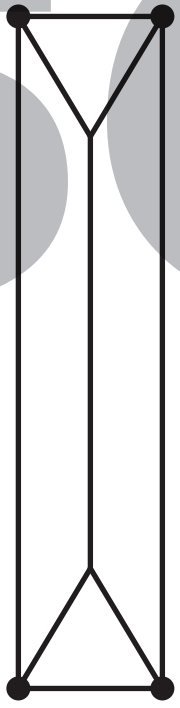

FOLD BACK THIS MARGIN

D2

D3

PAGE

51

14

12

10

8

6

4

2

FOLD BACK THIS MARGIN

D3

D4



PAGE



20 18 16 14 12 10 8 6 4 2

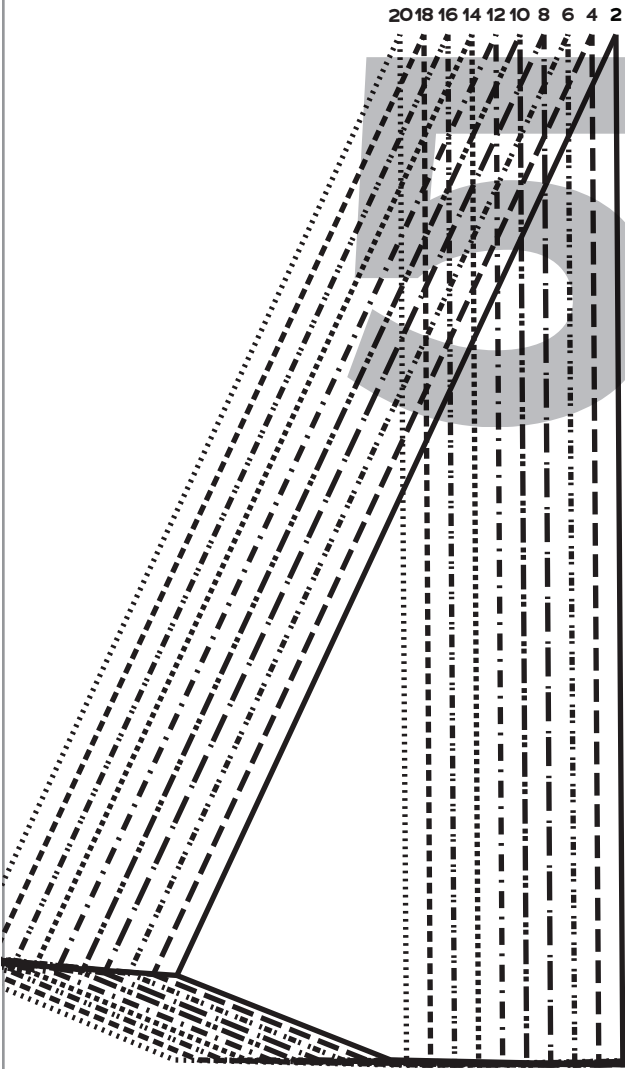

2

FOLD BACK THIS MARGIN

D4

D5

PAGE  
53

20

18

16

14

12

10

8

6

FOLD BACK THIS MARGIN

D5

D6

Society  
of CHARM  
*Rizzo*

JACKET  
SIZES 2-20

11

Lining  
Back

Cut 1 lining on fold

PAGE

54

FOLD BACK THIS MARGIN

D6

D7

FOLD

PAGE

55

*Rizzo*

JACKET  
SIZES 2-20

*Society  
of CHARM*

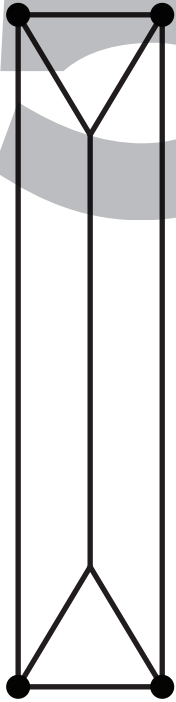

14

Welt Pocket Interfacing

Cut 1 interfacing

FOLD BACK THIS MARGIN



PAGE

56

FOLD BACK THIS MARGIN

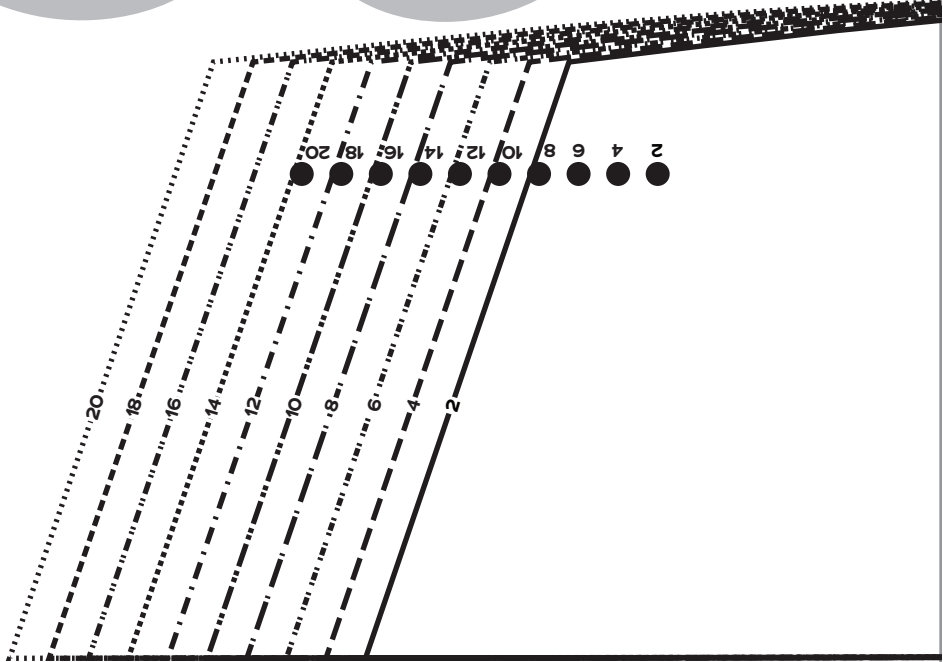
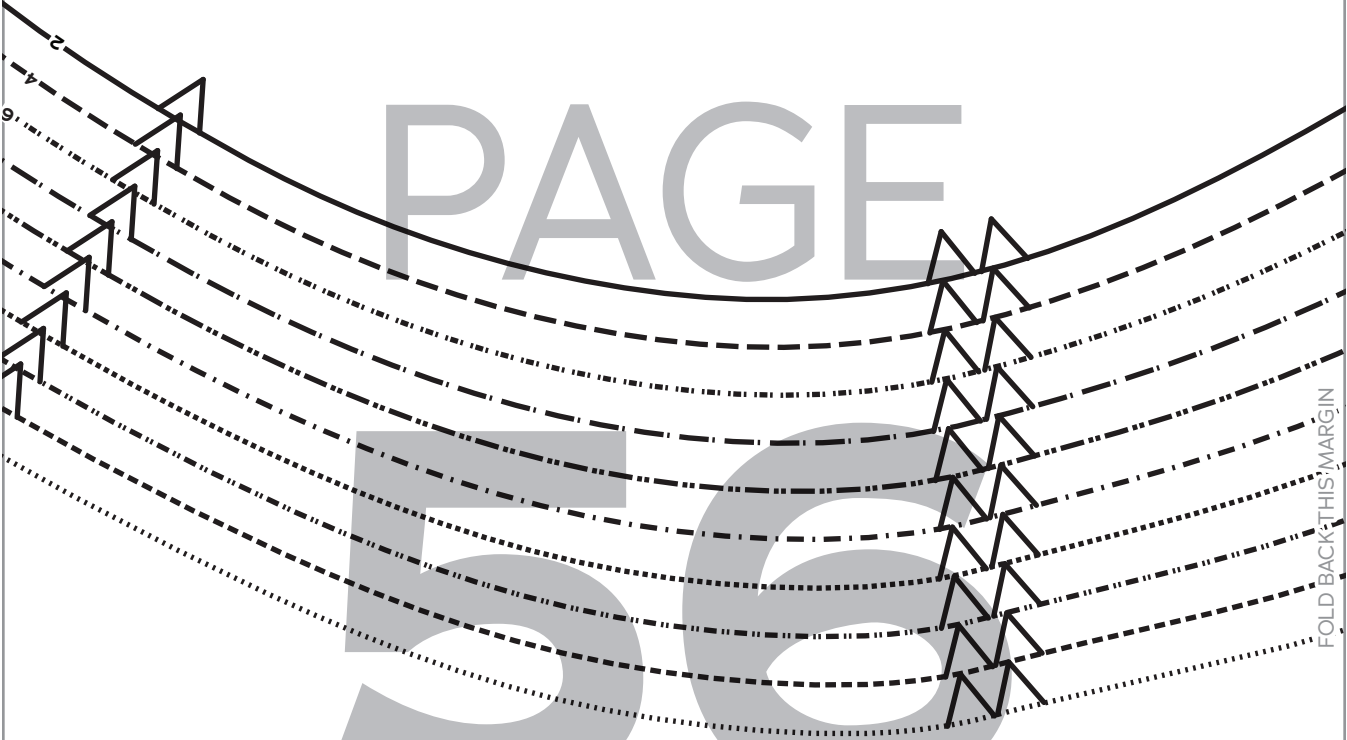



D8

D9

PAGE

57

FOLD BACK THIS MARGIN

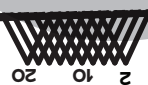

Cut 2 fabric on fold,  
1 interfacing on fold

Collar

8

JACKET  
SIZES 2-20



D9

D10

18

20

PAGE

58

FOLD BACK THIS MARGIN

D10

D11

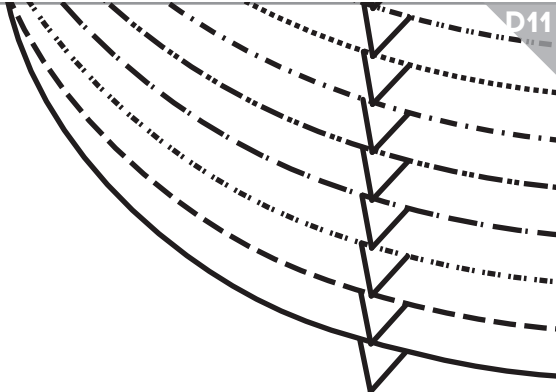

PAGE

59

GRAINLINE

FOLD BACK THIS MARGIN

*Society*  
of CHARM  
*Rizzo*

JACKET  
SIZES 2-20

1

Jacket Front,  
H Cup  
Cut 2 fabric



2018 16 14 12 10 8 6 4 2

2018 16 14 12 10 8 6 4 2

D11

